

INSTRUCTION MANUAL

ISO 9001 : 2015 CERTIFIED



***LIGHTWEIGHT
ABRASIVE
BLASTING HELMET***



Sand Blasting Helmet



LIGHTWEIGHT ABRASIVE BLASTING HELMET

CONTENTS

Read all instructions and warnings before using this product.
Keep this manual for future reference.

| | |
|---|-------------|
| ----- INTRODUCTION | 3 |
| ----- RESPIRATOR COMPONENT CONCEPT | 4 |
| ----- WARNINGS | 5 |
| ----- RESPIRATOR OPERATION | 6 |
| ----- SPECIAL OR CRITICAL USERS INSTRUCTIONS - BREATHING AIR PRESSURE TABLE | 7 |
| ----- RESPIRATOR USE / LENSES | 8 |
| ----- SETTING UP | 9-10 |
| ----- DOFFING YOUR HELMET / INSPECTION, CLEANING AND STORAGE | 12 |
| ----- PARTS AND ACCESSORIES | 14 |
| ----- | |



INTRODUCTION

The JM BLASTING HELMET SUPPLIED - AIR RESPIRATOR is specifically designed for use during Abrasive Blasting. The JM BLASTING HELMET has been designed for use in atmospheres NOT IMMEDIATELY DANGEROUS TO LIFE OR HEALTH, and from which a user can escape without the aid of the respirator.

The JM BLASTING HELMET to provide respiratory protection in abrasive blasting and painting applications. The cape is designed to protect the wearer's upper body from rebounding abrasive.

RESPIRATOR COMPONENT CONCEPT

The JM BLASTING HELMET SUPPLIED AIR RESPIRATOR consists of three main components: RESPIRATOR HELMET ASSEMBLY, BREATHING TUBE ASSEMBLY, and AIR SUPPLY HOSE illustrated in Fig1.1. All three components must be present and properly assembled to constitute.

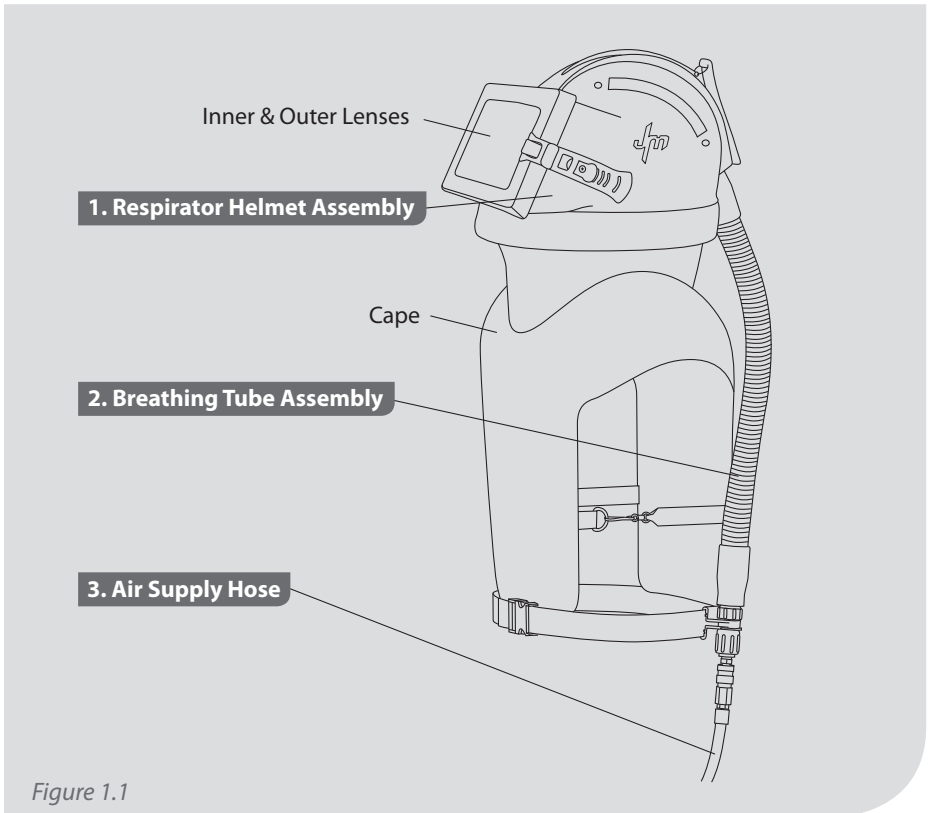

Figure 1.1

!WARNING! Failure to use genuine parts and components that are part of the JM brand approved respirator assembly will void the approval of the entire respirator assembly.

!WARNINGS!

1. Do not use this respirator until you have been trained in the respirators use, maintenance and limitations by a qualified individual (appointed by your employer) who has extensive knowledge of the JM BLASTING HELMET Respirator.
2. DO NOT wear this respirator if any of the following conditions exist:
 - Atmosphere is immediately dangerous to your life or health.
 - You CAN NOT escape without the aid of the respirator.
 - Atmosphere contains less than 19.5% oxygen.
 - Work area is poorly ventilated.
 - Contaminants are in excess of regulations or recommendations.
 - Radiation exists in the work area, or materials are Radioactive.
3. Inspect all components of the respirator daily for signs of damage or wear and tear that may reduce the level of protection originally provided.
4. DO NOT use abrasives containing silica, lead, arsenic or sharp glass particles
 - use of abrasives containing these elements could result in serious Injury or death.
5. DO NOT wear this respirator until you have passed a complete physical exam including a lung X-ray conducted by qualified medical personnel.
6. Improper use of this respirator may cause injury or death. Improper use may also cause life threatening delayed lung diseases such as silicosis, pneumoconiosis or asbestosis.
7. This respirator, when properly fitted and used, significantly reduces but does not completely eliminate the breathing of contaminants by the respirator wearer.
8. BE CERTAIN your employer has determined that the breathing air source provides at least Grade D breathable air. The respirator must be supplied with clean filtered breathing air at all times.
9. DO NOT connect the respirator's air supply hose to nitrogen, toxic gases, inert gases, or other unbreathable non Grade D air sources. Check the air source before using the respirator. Failure to connect the supply hose to the proper air source could result in serious injury or death.
10. DO NOT use this respirator in poorly ventilated areas or confined spaces. Ensure the area is well ventilated and that the contaminant concentrations are below those recommended for this respirator. Follow all procedures for confined space entry, operation and exit as defined in applicable regulations and standards.
11. LEAVE WORK AREA IMMEDIATELY IF:
 - Any respirator component becomes damaged.
 - Airflow stops or slows down.
 - Breathing becomes difficult.
 - You become dizzy, nauseous, too hot, too cold or ill.
 - Vision is impaired.
12. DO NOT wear this respirator if the ambient usage temperature is below -10°C or above +60°C.

RESPIRATOR OPERATION

AIR QUALITY

This respirator must be supplied with clean breathable air, Grade D or better, at all times. The JM BLASTING HELMET does not purify air or filter contaminants.

Breathable air must be supplied to the point of attachment of the JM Safety air supply hose. Supplied breathing air must at least meet the requirements for Type 1 gaseous air described in the Compressed Gas Association Commodity Specifications G.7.1 (Grade D or higher)

AIR SOURCE

Locate the air source in a clean air environment, always use a filter on the inlet of your air source. Do not park vehicles beside your air inlet as this will cause carbon monoxide to be drawn into your air supply. Use suitable after coolers / dryers with filters and carbon monoxide alarms to assure clean breathable air is supplied at all times. The air should be regularly sampled to ensure that it meets Grade D requirements.

AIR SUPPLY HOSE AND FITTINGS

JM Safety air supply hoses must be used between the point of attachment and the respirator breathing air connection at the wearer's belt. JM Safety quick disconnect fittings must be used to connect the hose lengths together. The hose sections must be within the approved length and the amount of sections must be within the number specified in the Breathing Air Pressure Table on page 7.

BREATHING AIR PRESSURE

The air pressure must be continually monitored at the point of attachment while the air is flowing to the respirator. Air pressure must be read from a reliable pressure gauge whilst the respirator has air flowing through it.

!WARNING! Failure to supply the respirator with the minimum required pressure at the point of attachment for the length of air supply hose used could result in contaminants being inhaled as the pressure in the helmet may become negative due to peak inhalation flow when working at very high work rates.



SPECIAL OR CRITICAL USERS INSTRUCTIONS

BREATHING AIR PRESSURE TABLE

This table list air pressure ranges needed to provide the JM BLASTING HELMET with the volume of air that falls within the required range of 6-15cfm.

BEFORE USING THIS RESPIRATOR MAKE SURE YOU UNDERSTAND THE TABLE BELOW.

| 1. AIR SOURCE | 2. BREATHING TUBE ASSEMBLY AND FLOW CONTROL DEVICES | 3. AIR SUPPLY HOSE | 4. SUPPLY HOSE LENGTH | 5. MAX NUMBER OF SECTIONS | 6. PRESSURE RANGE (PSIG AIR) | |
|---|---|--------------------------|--------------------------------|------------------------------------|---------------------------------------|-------|
| Portable or Stationary Compressor | JM 08-2511 | JM 2528 (25ft.) | 25 | 1 | 26-27 | |
| | JM 2511 | JM 2529 (50ft.) | 50 | 2 | 27-28 | |
| | Flow Control Valve Assembly | | JM 2527 (100ft.) | 100 | 2 | 30-31 |
| | | | | 150 | 3 | 33-34 |
| | | | | 200 | 4 | 36-37 |
| | | | | 250 | 5 | 38-39 |
| 300 | 6 | 41-43 | | | | |

Set the air pressure at the point of attachment within the range specified in column 6 for your breathing tube assembly, hose length and amount of hose sections. Make sure air is flowing through your respirator when setting the pressure.

!WARNING! RESPIRATORS MUST BE SUPPLIED WITH RESPIRABLE AIR MEETING THE REQUIREMENTS OF CGA G-7.1 GRADE D OR HIGHER QUALITY.

RESPIRATOR USE

AIRFLOW CONTROL VALVE

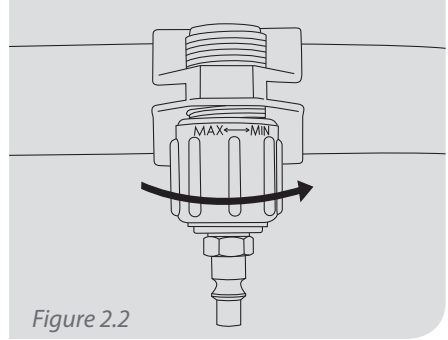
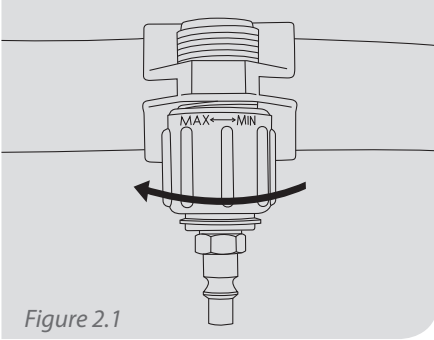

Air flowing into the helmet is controlled using the regulator as shown in Fig 2.1 and 2.2.

NOTE: The minimum of 170 Vmin should be flowing through the helmet when the regulator is in the closed position as in Fig 2.2 and the pressure set in accordance with the table on page 8.

LENSES

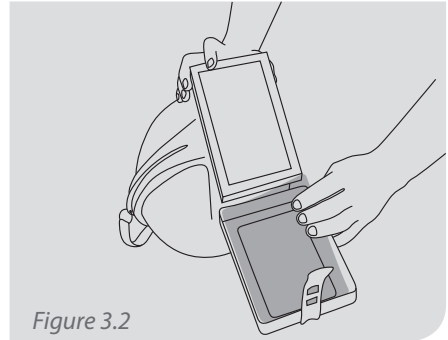
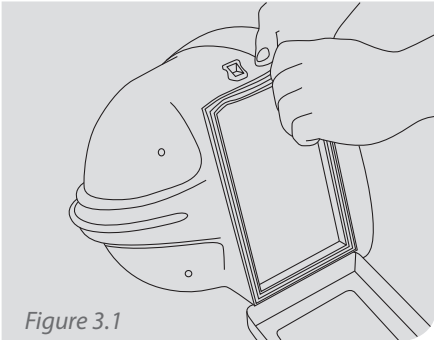

Inner Lens

Place one end into the gasket first, then slowly roll the gasket over the sides of the lens, working towards the other end.

Outer Lens

Place the lens into the face frame and push past the locating ribs.

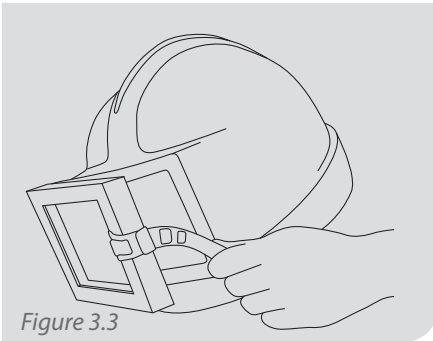

Figure 3.3

Fold the visor across the front of the helmet and lock the strap tightly over the side cleat.

SETTING UP

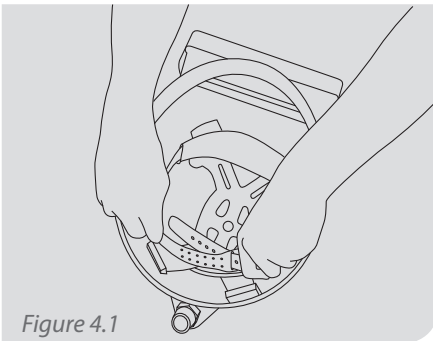

Figure 4.1

NOTE

Always make sure that a JM Safety inner lens is securely fitted into the window frame gasket. Proceed fitting lenses as Fig 3.1, Fig 3.2, Fig 3.3.

Head Harness

To adjust the head harness first unclip the locating pegs, then slide the band in or out to the desired size. Note: slide inwards to reduce the size. Once the desired size is obtained, clip the locating pegs back together.

Putting the Helmet in Place

Hold the helmet in front of you, holding the inner bib collar open. Lift the helmet and place it on your head making sure the head harness fits securely.

SETTING UP

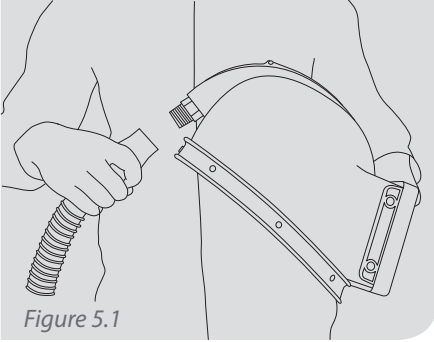

First screw on the breathing hose in a clockwise direction onto the helmet.

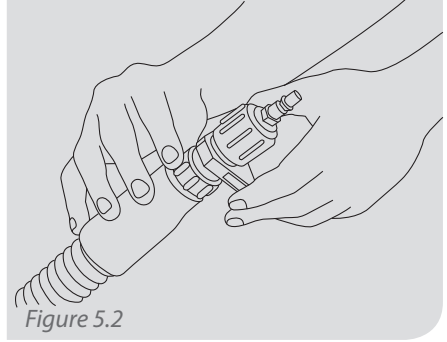

Screw the loose running nut in a clockwise direction onto the flow control device (2511).

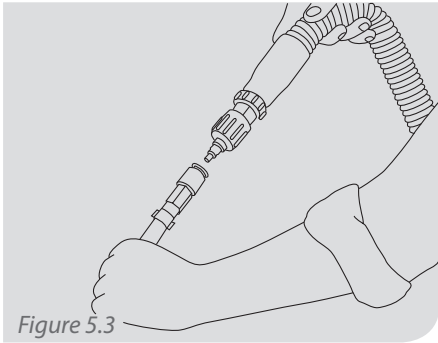

Take the quick dis-connect fitting on the Air Supply Hose and push onto the tail of the Flow Control Device.

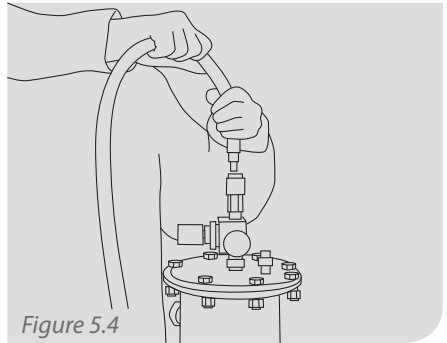

Connect the Air Supply Hose Tail to the point of attachment supplying Grade D air.

FITTING THE CAPE AND BELT

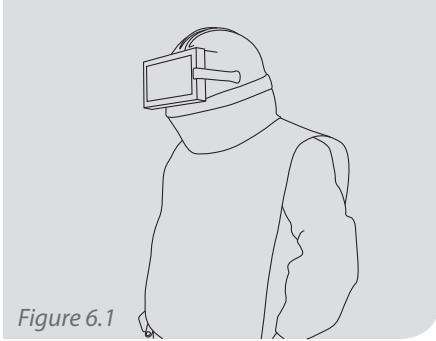

Figure 6.1

Once the helmet is fitting comfortably on your head, straighten the cape down at the front and back.

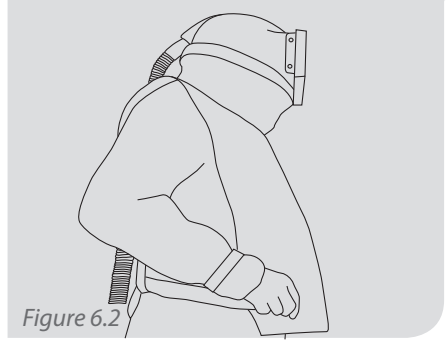

Figure 6.2

Place the Flow Control Device to your desired hip pocket.

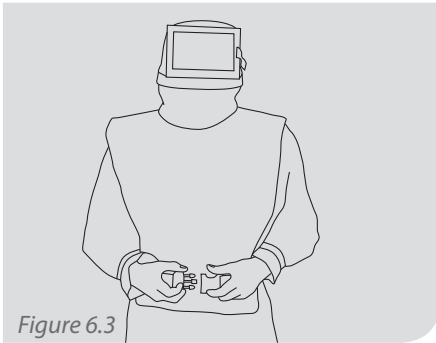

Figure 6.3

Now bring both buckles together at the front and push them until you hear a click. Pull the tab to tension the belt to your requirement.

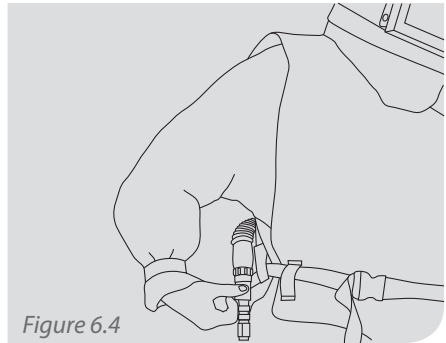

Figure 6.4

Now the helmet is fully fitted and the belt tightened, adjust the airflow into the helmet with the Flow Control Device adjustment barrel see Fig 2.1 on Page 7. Again check the air pressure at the source to make sure it is still in accordance with Table 1.1 on page 7.

DOFFING YOUR HELMET

To remove the helmet, first exit the working area and reverse procedures in Respirator Use.

!WARNING! NEVER remove your helmet when in the working area.

INSPECTION, CLEANING AND STORAGE

The JM BLASTING HELMET Supplied Air Respirator has a limited service life, therefore a regular inspection and replacement programmed must be conducted. Certain parts such as lenses must be replaced frequently.

All components of the respirator assembly should be inspected for damage or wear and tear before use. Replace worn or damaged parts immediately. USE ONLY JM SAFETY PARTS. Refer to the parts list for the correct part numbers.

!WARNING! DO NOT CLEAN RESPIRATOR WITH VOLATILE CHEMICALS.

REMOVING THE CAPE

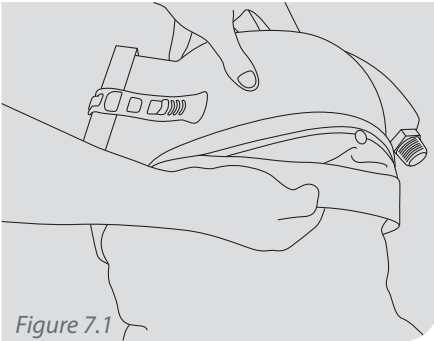

Figure 7.1

First remove the cape cover band to reveal the eight press studs. The cape can then easily be removed by undoing the four press studs.

INSPECTING THE HELMET

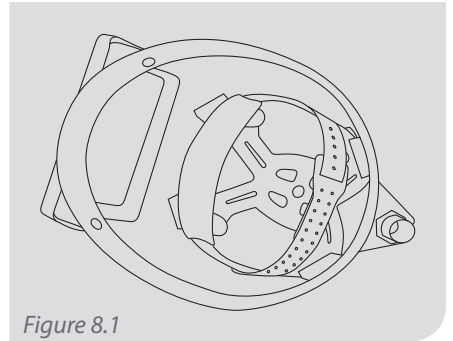

Figure 8.1

Having removed the cape, wipe out the inside of the helmet with a soft cloth and mild detergent. Check the inside for cracks in the shell and damage to the air inlet.

INNER LENS AND GASKET

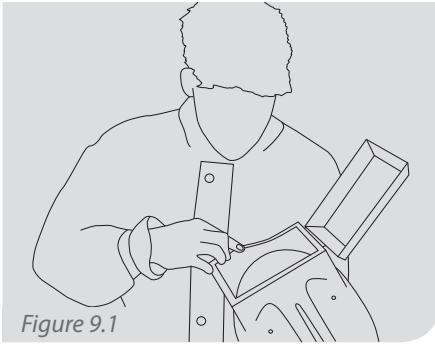

Figure 9.1

Make sure the window frame gasket is securely fitted in the helmet with no cracks or tears in the seal. Check that the inner lens is correctly fitted into the gasket. When necessary replace lenses as in Figures 3.1 and 3.2.

BREATHING TUBE ASSEMBLY

Inspect the breathing tube for cracks, tears or excessive wear. Check that the fittings are secured into the cuffs tightly, not allowing any air leaks.

Replace the hose as soon as any signs of damage or excessive wear become evident. Do not remove the foam that is inside the breathing tube as this is a critical component.

!WARNING! Air leaks will cause a drop in air flow through the respirator helmet resulting in less protection from contaminants.

AIR SUPPLY HOSE

The air supply hoses should be inspected for:

1. Cuts or tears
2. Cracks or signs of perishing
3. Blisters or weak points
4. Abrasive wear the hose or are not worn, remove any dirt inside couplings with a duster gun.
5. Ferrules firmly crimped in place
6. Quick disconnect couplers do not move in.

STORAGE

After the respirator components have been cleaned and inspected, place them in a plastic bag or an airtight container. Store the respirator parts away from excessive heat, dust, cold, moisture or harmful chemicals.

After use hang the respirator up by the hand strap, this will help keep the inside of the helmet free of contaminants.

PARTS AND ACCESSORIES

VISOR AND LENSES

Figure 10.1

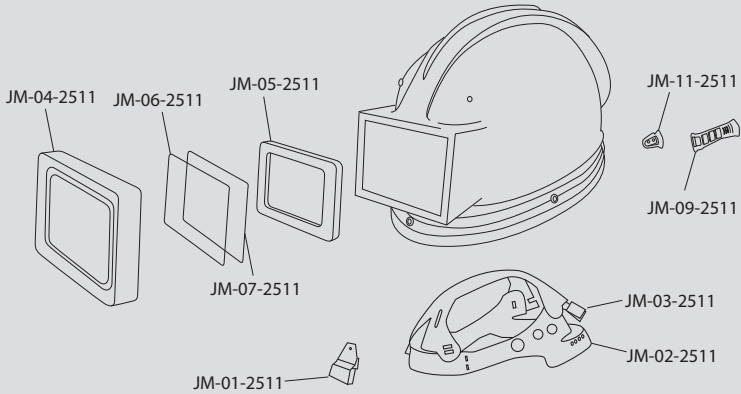

- JM-01-2511 Suspension Clip (pkt 4)
- JM-02/03-2511 Head Suspension
- JM-04-2511 Visor
- JM-05-2511 Gasket Seal
- JM-06-2511 Inner Lens

- JM-07-2511 Outer Lens (pkt 5)
- JM-09-2511 Visor Strap
- JM-11-2511 Cleat

AIR SUPPLY HOSES

Figure 10.2

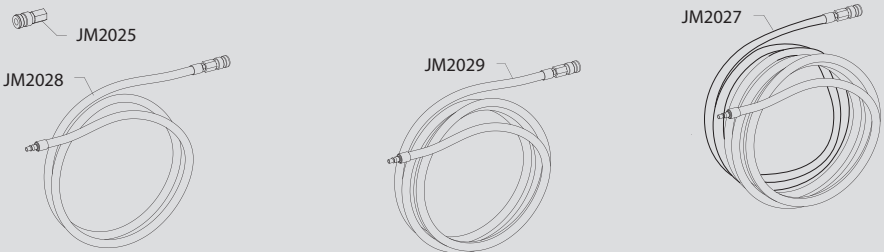

- JM2027 100ft Air Supply Hose
- JM2028 25ft Air Supply Hose
- JM2029 50ft Air Supply Hose

- JM2025 Quick Release Coupler

BREATHING TUBE & FLOW CONTROL DEVICES *Figure 10.3*

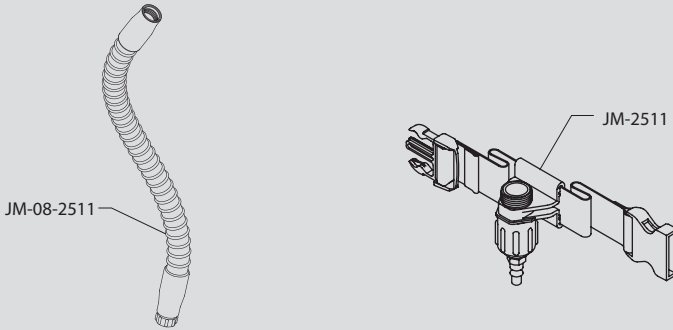

- JM-08-2511 Breathing Tube
- JM-2511 Flow Control Valve Assembly -
Includes: Flow Control Valve, Belt

RESPIRATOR CAPES *Figure 10.4*

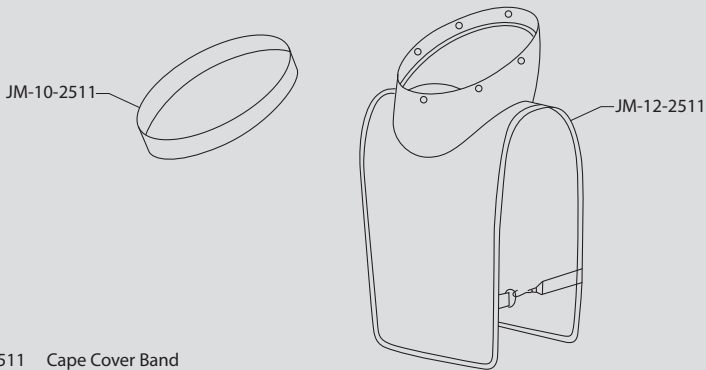

- JM-10-2511 Cape Cover Band
- JM-12-2511 Safety Apparel



Gasket Seal & Lance



Flow Control Valve with Belt



Visor, Visor Strip & Cleat



Cap Cover Band



Head & Clip Suspension



Air Coupling



Air Breathing Tube



Safety Apparel

LIGHTWEIGHT ABRASIVE BLASTING HELMET



ISO 9001:2015 CERTIFIED

Marketed by :

